

COMPASS SERIES Decorative Poles

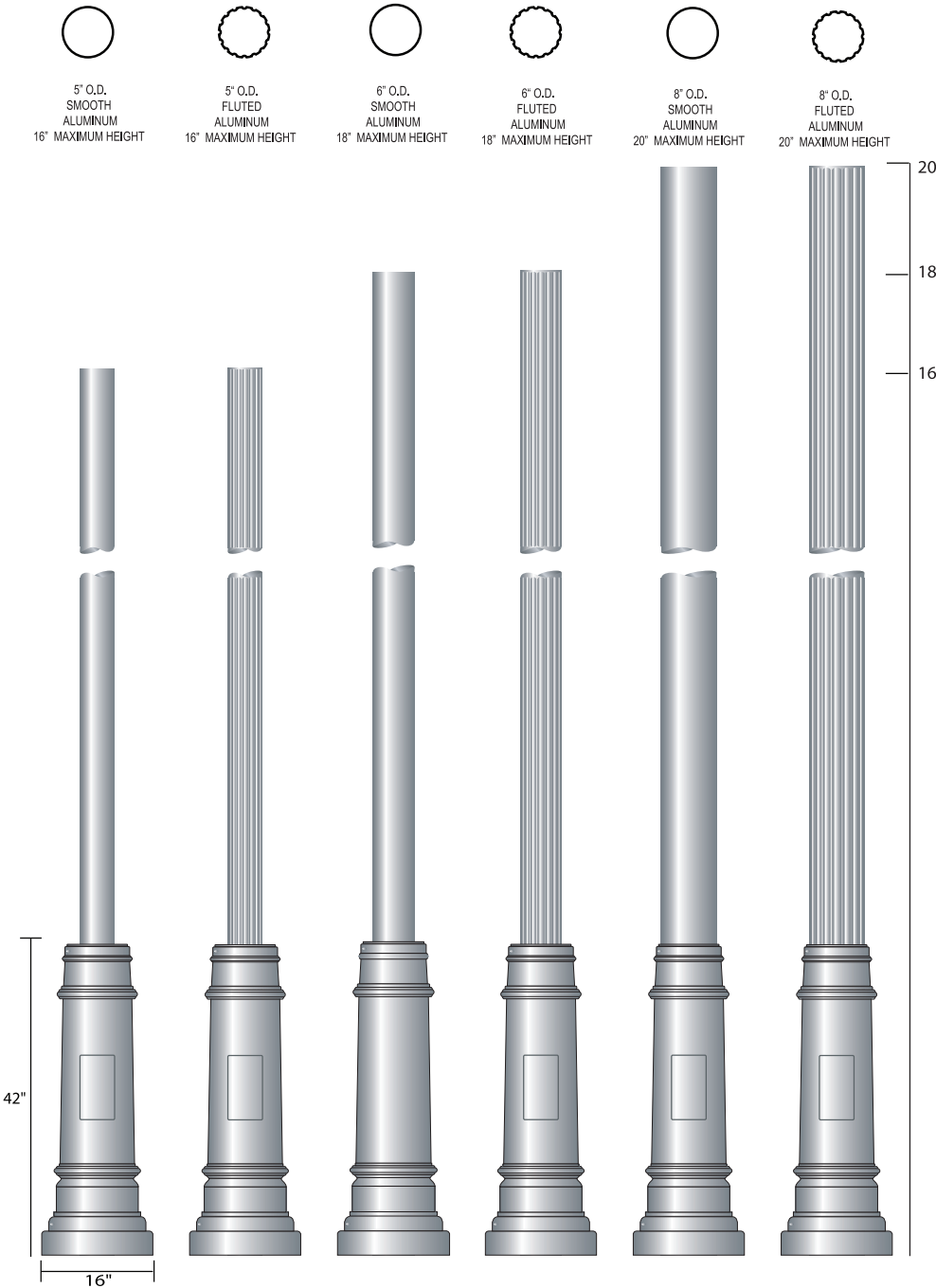

12DP-COS-5NTR-SM 12DP-COS-5NTR-FL 12DP-COS-6NTR-SM 12DP-COS-6NTR-FL 12DP-COS-8NTR-SM 12DP-COS-8NTR-FL

BASE SPECIFICATIONS

The decorative base is constructed of two identical cast clamshells using A356 alloy aluminum or equivalent. Clamshell bases are designed to wrap around the pole with a circular hole tolerance of .25" maximum between the base and casting. For fluted poles, the flutes start 1-2" above the top of the base to eliminate gaps.

SHAFT SPECIFICATIONS

The shaft is seamlessly extruded from 6061 aluminum alloy. After being spun tapered and fluted, or straight extruded, the shaft is inserted and welded into a structural base casting.

ANCHOR BOLTS AND BASE PLATE

Anchor bolts are hot dip galvanized per ASTM A153. Each anchor bolt is supplied with two hex nuts and two flat washers. Base plates are seam welded for strength. The a/b slots are slotted and slightly oversized for a 1/4" tolerance.

FINISH

The finish for the pole is polyester powder applied coating unless otherwise specified. Custom colors and finishes are available.

